

2N6702, 2N6703, 2N6704

File Number 1187

High-Current, Silicon N-P-N VERSAWATT Transistors

Switching Applications

Features:

- Fast switching speed at temperatures up to 125° C
- Low $V_{CE(sat)}$
- **VERSAWATT** plastic package

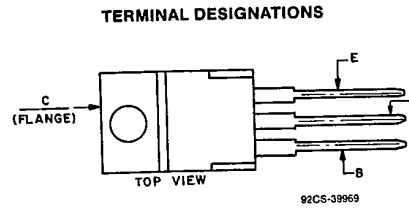

JEDEC TO-220AB

RCA-2N6702, 2N6703, and 2N6704* epitaxial-base silicon n-p-n power transistors which feature fast switching speeds, low saturation voltages, and high safe-operating-area (SOA) ratings. They are specially designed for converters, inverters, pulse-width-modulated regulators and a variety of power switching circuits.

The 2N6702, 2N6703, and 2N6704 transistors are supplied in the JEDEC TO-220AB (RCA VERSAWATT) plastic packages.

*Formerly RCA Dev. Type Nos. TA9164A, TA9164B, TA9164C, respectively.

MAXIMUM RATINGS, Absolute-Maximum Values:

	2N6702	2N6703	2N6704	
* V_{CEV}	140	160	180	V
$V_{BE} = -1.5$ V	90	110	130	V
* V_{CEO}		7		V
* V_{EBO}	5	5	4	A
$I_C(sat)$		7		A
* I_C		10		A
I_{CM}		5		A
* I_B				A
* P_T		50		W
T_C up to 25° C		0.4		W/°C
T_C above 25° C		-65 to 150		°C
* T_{stg}, T_J				°C
* T_L		235		°C
At distance $\geq 1/8$ in. (3.16 mm) from seating plane for 10 s max.				

*In accordance with JEDEC registration data.

2N6702, 2N6703, 2N6704

ELECTRICAL CHARACTERISTICS, at Case Temperature $T_C = 25^\circ\text{C}$ Unless Otherwise Specified

CHARACTERISTIC	TEST CONDITIONS				LIMITS						UNITS
	VOLTAGE V dc		CURRENT A dc		2N6702		2N6703		2N6704		
	V_{CE}	V_{BE}	I_C	I_B	Min.	Max.	Min.	Max.	Min.	Max.	
* I_{CEV}	140 160 180	-1.5 -1.5 -1.5			-	100	-	-	-	-	μA
$T_C = 125^\circ\text{C}$	140 160 180	-1.5 -1.5 -1.5			-	1	-	-	1	-	mA
* I_{EBO}		-7	0		-	100	-	100	-	100	μA
* $V_{CEO(sus)b}$			0.01 ^a	0	90	-	110	-	130	-	V
* h_{FE}	2 2 2		0.2 ^a 4 ^a 5 ^a		30 - 20	- - -	30 - 20	- - -	30 20 -	- - -	
* $V_{BE(sat)}$			4 ^a 5 ^a	0.4 0.5	- -	- 1.5	- -	- 1.5	- -	1.4 -	V
* $V_{CE(sat)}$			4 ^a 5 ^a 7 ^a	0.4 0.5 0.7	- - -	- 0.8 1.5	- - -	- 0.8 1.5	- - -	0.7 - 1.5	
* $I_{S/b}$	20		2.5		1	-	1	-	1	-	s
* $ h_{fe} $ f = 5 MHz	10		0.5		10	40	10	40	10	40	
* f_T	10		0.5		50	200	50	200	50	200	MHz
* C_{obo} f = 0.1 MHz	10 ^c				50	150	50	150	50	150	pF
* t_{d^d}		-4	4 5	0.4 0.5	- -	- 0.1	- -	- 0.1	- -	0.1 -	
* t_r^d		-4	4 5	0.4 0.5	- -	- 0.25	- -	- 0.25	- -	0.25 -	μs
* t_s^d		-4	4 5	0.4 ^e 0.5 ^e	- -	- 1	- -	- 1	- -	1 -	
* t_f^d		-4	4 5	0.4 ^e 0.5 ^e	- -	- 0.5	- -	- 0.5	- -	0.5 -	
* $R_{\theta JC}$	4		5		-	2.5	-	2.5	-	2.5	$^\circ\text{C/W}$

* In accordance with JEDEC registration data.

^a Pulsed: pulse duration = 300 μs , duty factor $\leq 2\%$.

^b CAUTION: The sustaining voltage $V_{CEO(sus)}$ MUST NOT be measured on a curve tracer.

^c V_{CB} value.

^d $V_{CC} = 70\text{ V}$, $t_p = 20\ \mu\text{s}$

^e $I_{B1} = -I_{B2}$.

2N6702, 2N6703, 2N6704

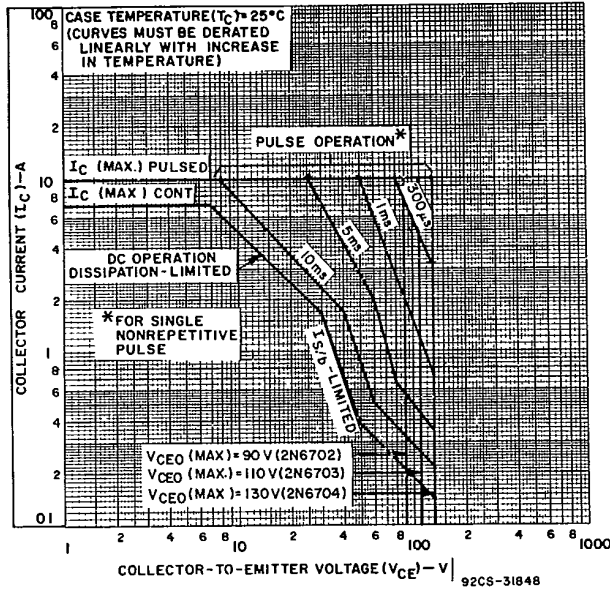

Fig. 1 - Maximum operating areas for all types
($T_C = 25^\circ C$).

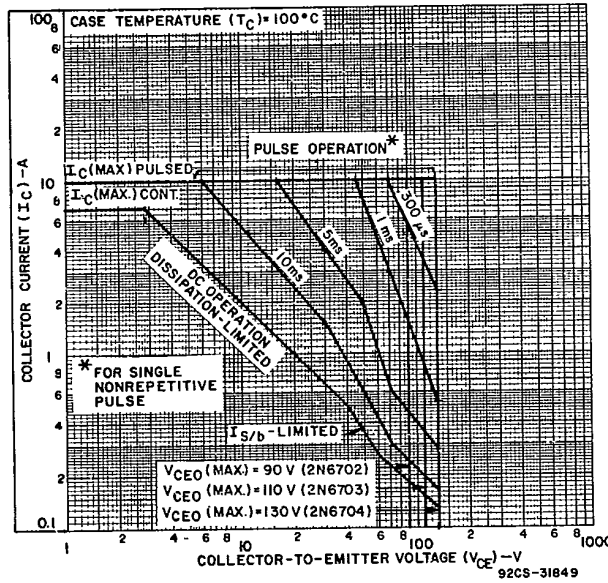

Fig. 2 - Maximum operating areas for all types
($T_C = 100^\circ C$).

2N6702, 2N6703, 2N6704

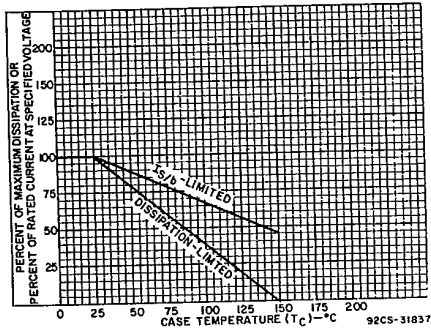

Fig. 3 - Dissipation and I_{S/I_B} derating curves for all types.

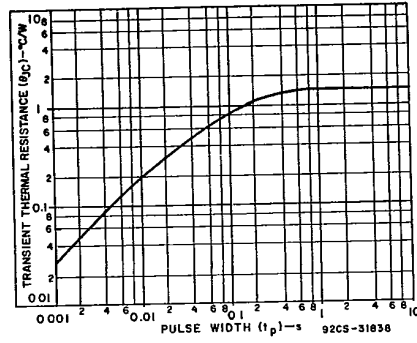

Fig. 4 - Typical thermal-response characteristic for all types.

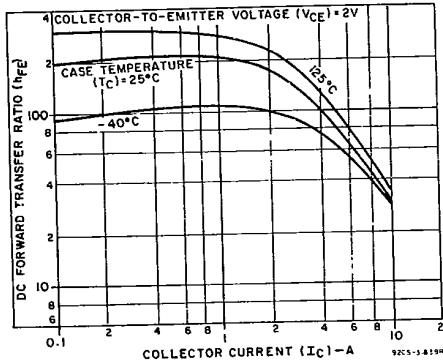

Fig. 5 - Typical dc beta characteristics for all types.

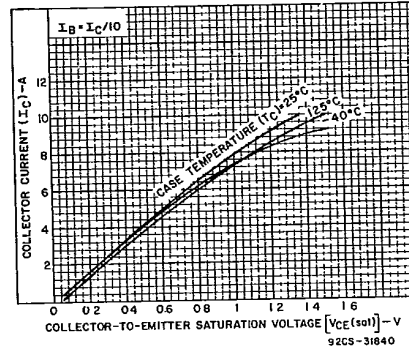

Fig. 6 - Typical collector-to-emitter saturation voltage characteristics for all types.

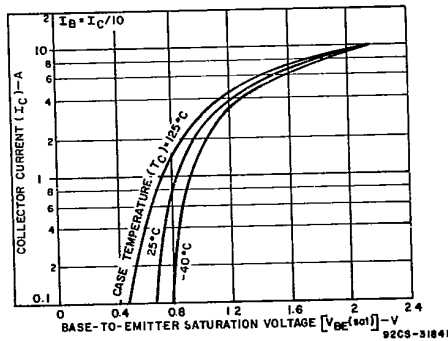

Fig. 7 - Typical base-to-emitter saturation voltage characteristic for all types.

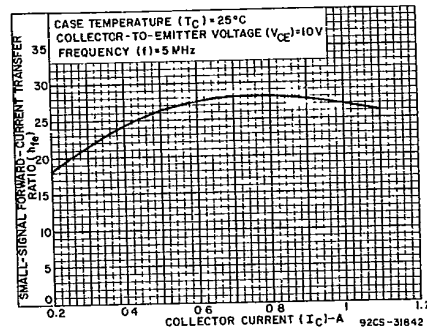

Fig. 8 - Typical small-signal forward-current transfer ratio characteristic for all types ($f = 5 \text{ MHz}$).

2N6702, 2N6703, 2N6704

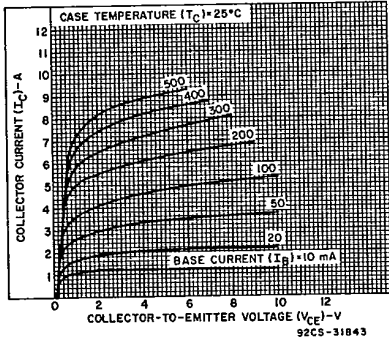

Fig. 9 - Typical output characteristics for all types.

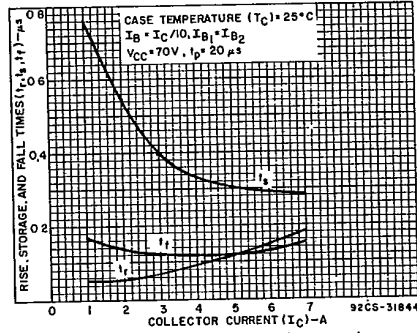

Fig. 10 - Typical saturated-switching-time characteristics as a function of collector current for all types ($T_C = 25^\circ C$).

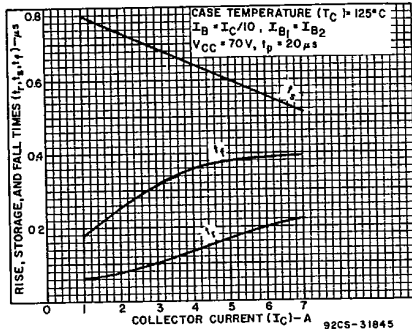

Fig. 11 - Typical saturated-switching-time characteristics as a function of collector current for all types ($T_C = 125^\circ C$).

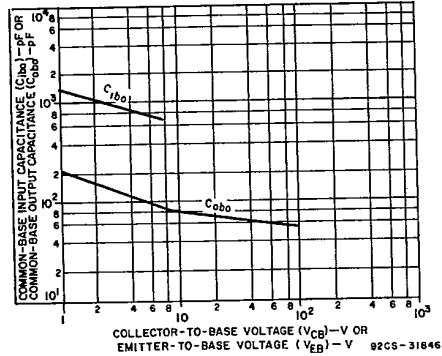

Fig. 12 - Typical common-base input (C_{ibo}) or output (C_{obo}) capacitance characteristic for all types.

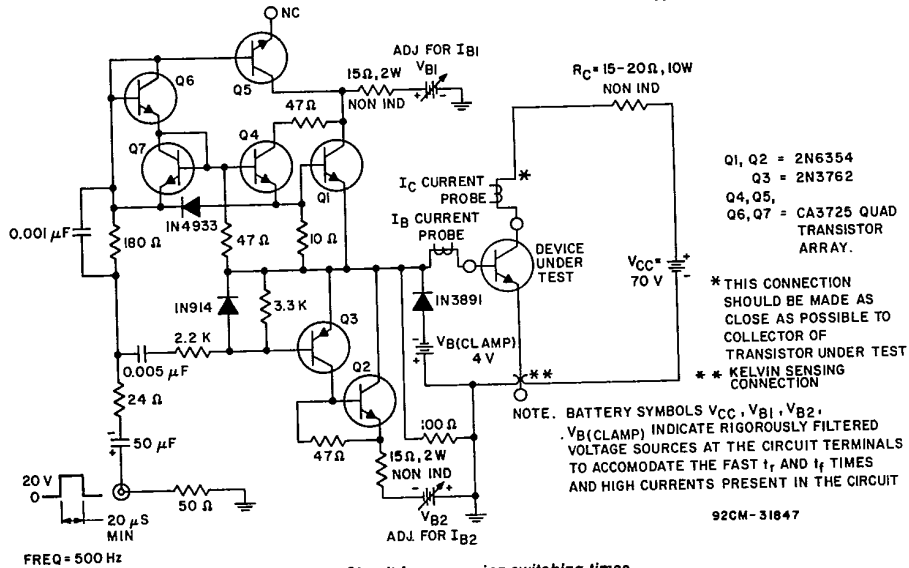
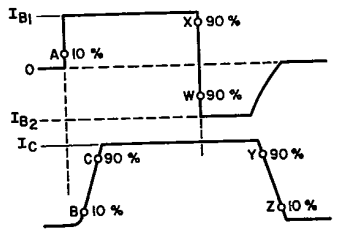

Fig. 13 - Circuit for measuring switching times.

2N6702, 2N6703, 2N6704



92CS-3038IR1

$t_f = A-B$ $t_r = X-Y$
 $t_f = B-C$ $t_r = Y-Z$
 $t_{transition} = X-W$

NOTE: TRANSITION TIME FROM 90% I_{B1} TO 90% I_{B2} MUST BE LESS THAN 0.5 μs .

Fig. 14 - Phase relationship between input and output currents showing reference points for specification of switching times.